

ISTRUZIONI PER L'INSTALLAZIONE E LA MANUTENZIONE
INSTRUCTIONS DE MISE EN SERVICE ET D'ENTRETIEN
INSTRUCTIONS FOR INSTALLATION AND MAINTENANCE
INSTALLATIONSANWEISUNG UND WARTUNG
INSTRUCTIES VOOR INGEBRUIKNAME EN ONDERHOUD
INSTRUCCIONES PARA LA INSTALACION Y EL MANTENIMIENTO
ИНСТРУКЦИИ ПО МОНТАЖУ И ТЕХНИЧЕСКОМУ ОБСЛУЖИВАНИЮ
NÁVOD K INSTALACI A ÚDRŽBĚ
INSTRUKCJA MONTAŻU I KONSERWACJI
ΟΔΗΓΙΕΣ ΓΙΑ ΤΗΝ ΕΓΚΑΤΑΣΤΑΣΗ ΚΑΙ ΤΗΝ ΣΥΝΤΗΡΗΣΗ
KURMA VE BAKIM BİLGİLERİ
ІНСТРУКЦІЇ ЗІ ВСТАНОВЛЕННЯ ТА ТЕХНІЧНОГО ОБСЛУГОВУВАННЯ
INSTRUCȚIUNI PENTRU INSTALARE ȘI ÎNTREȚINERE
UPUTSTVO ZA INSTALACIJU I ODRŽAVANJE
安装和维护说明

FEKABOX 110

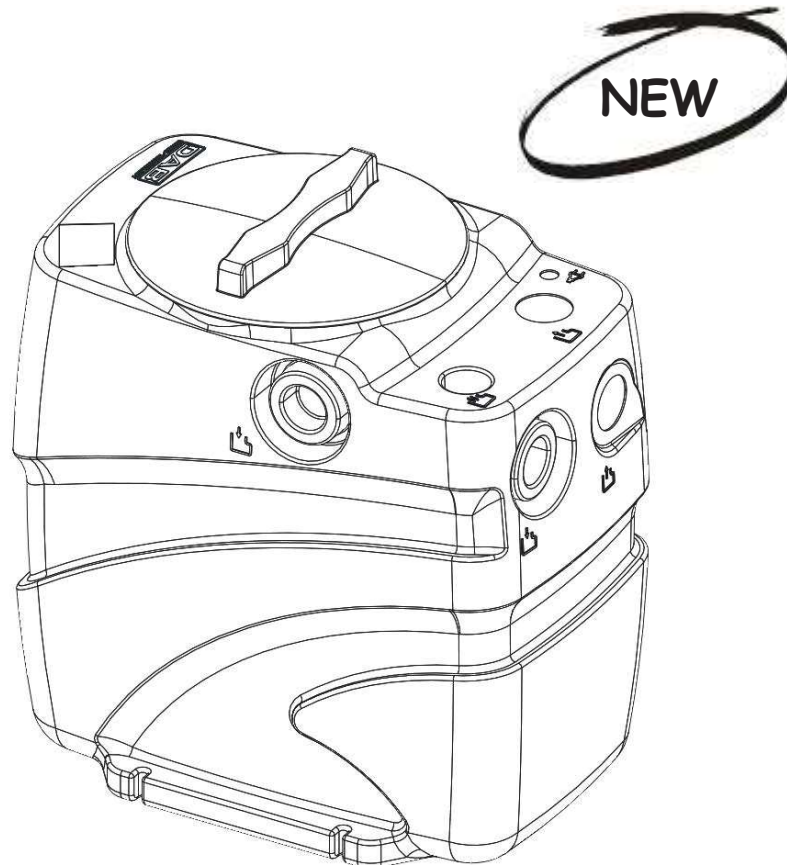







EN 12050/2



CONTENTS

1. WARNINGS.....	24
2. Responsibility.....	24
3. MANAGEMENT.....	24
3.1 Storage.....	24
3.2 Transport.....	24
4. EXAMPLE OF INSTALLATION.....	25
4.1 Dimensions and weights.....	26
5. TANK INSTALLATION.....	26
5.1 Placing the tank inside the building.....	27
5.2 Placing the tank outside the building.....	27
5.3 Making holes for the collection, delivery and ventilation pipes.....	27
5.4 Gluing the collection and ventilation pipes.....	28
5.5 Connecting the delivery pipe to the sewer network.....	28
5.6 Connecting the ventilation pipe.....	28
5.7 Closing the cover.....	29
5.8 Provision for emergency drainage.....	29
5.9 Non-return valve.....	29
5.10 Interception gate valve.....	29
6. PUMP INSTALLATION.....	30
7. ELECTRICAL CONNECTIONS.....	32
8. FIRST START-UP.....	32
8.1 Operating flow rate.....	32
8.2 Operation.....	33
9. MAINTENANCE.....	33
10. TROUBLESHOOTING.....	33
11. DISPOSAL.....	33

1. WARNINGS

- 1.1  **Before installation, carefully read this documentation and that supplied with the pump manual and the control panel.**
It is indispensable to have the electric and hydraulic connections made by skilled personnel, in possession of the technical qualifications indicated by the safety standards concerning the design, installation and maintenance of technical plants, in force in the country where the product is to be installed.
Failure to comply with the safety regulations not only causes risk to personal safety and damage to the equipment, but invalidates every right to assistance under guarantee.
- 1.2  The term **skilled personnel** means persons whose training, experience and instruction, as well as their knowledge of the respective standards and requirements for accident prevention and working conditions, have been approved by the person in charge of plant safety, authorizing them to perform all the necessary activities, during which they are able to recognize and avoid all dangers. (Definition for technical personnel IEC 364).
The appliance is not intended for use by persons (including children) with reduced physical, sensory or mental capabilities, or lack of experience and knowledge, unless they have been given supervision or instruction concerning use of the appliance by a person responsible for their safety. Children should be supervised to ensure that they do not play with the appliance
- 1.3  Check that the system has suffered no damage during transport or storage. In particular, ensure that the external casing is perfectly entire and in excellent condition; check the efficiency of all the tank components; replace any parts that are not perfectly efficient.
- 1.4  Do not use inflammable or highly corrosive liquids or anything other than indicated by standard EN 12050-2.
- 1.5  If the installation is indoors, adequate drainage must be ensured in the event of leakage from the tank
- 1.6  For correct installation, follow the instructions in chapters 3-4-5 below. If you want to install the Fekabox lifting tanks outside the home, **attention must be paid because the maximum admissible load on the cover is 100 kg (see also the symbols on the cover).**

2. RESPONSIBILITY

The Manufacturer does not vouch for correct operation of the machine or answer for any damage that it may cause if it has been tampered with, modified and/or run outside the recommended work range or in contrast with other indications given in this manual.

3. MANAGEMENT

3.1 Storage

All the products must be stored indoors, in a dry, vibration-free and dust-free environment, possibly with constant air humidity.

3.2 Transport

Avoid subjecting the products to needless jolts or collisions.

To lift and transport the tank, use lifting equipment and the pallet supplied standard (if applicable).

4. EXAMPLE OF INSTALLATION

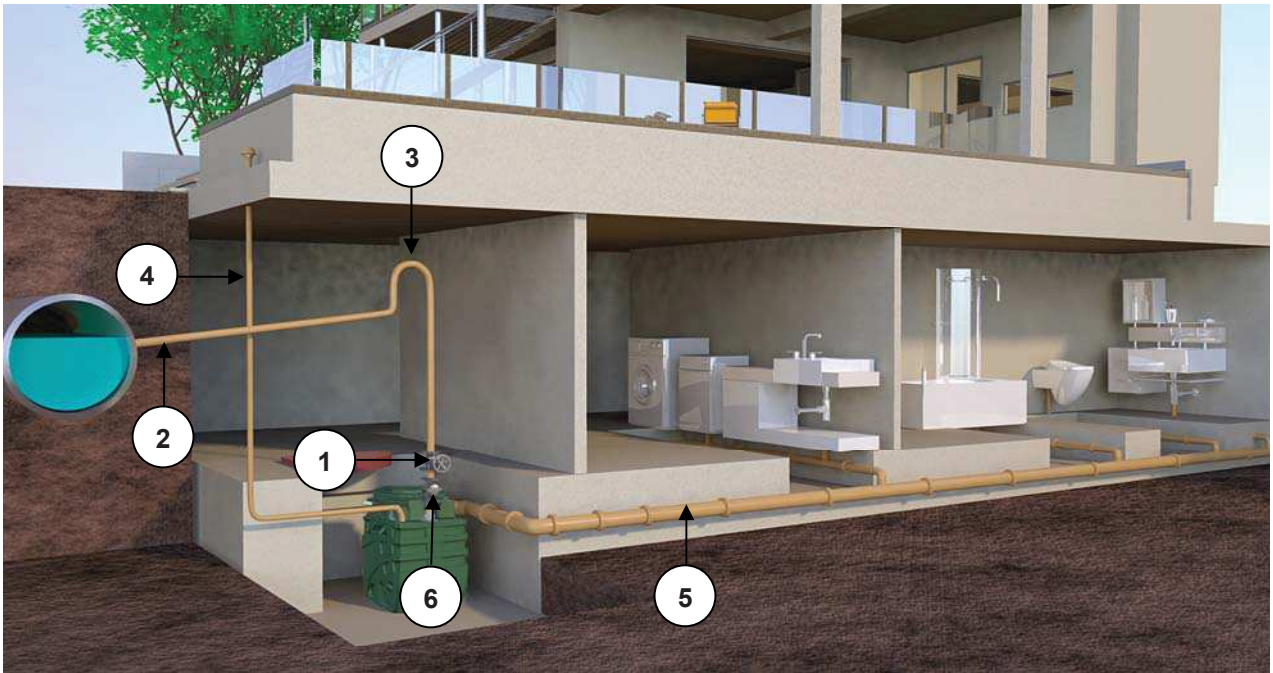

FEKABOX 110 are preassembled systems, ready for installation, requiring no adjustment, ideal for collecting and disposing of sewage and domestic waste water from basement rooms, situated below the level of the sewer network. In compliance with the accident-prevention regulations in force, the FEKABOX 110 cannot be used for conveying inflammable or explosive liquids, such as petrol, diesel fuel, combustible oils, solvents, etc.

- 1 - Interception ball or gate valve
- 2 - Delivery
- 3 - Siphon

- 4 - Ventilation
- 5 - Collecting pipe
- 6 - No Return Valve

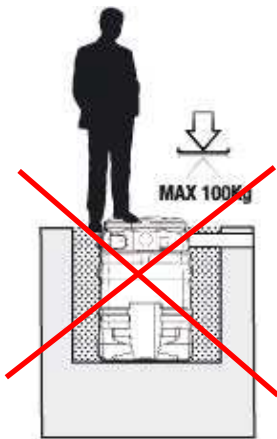

Fig. 1

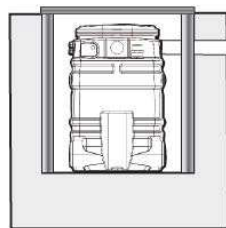

Fig. 2

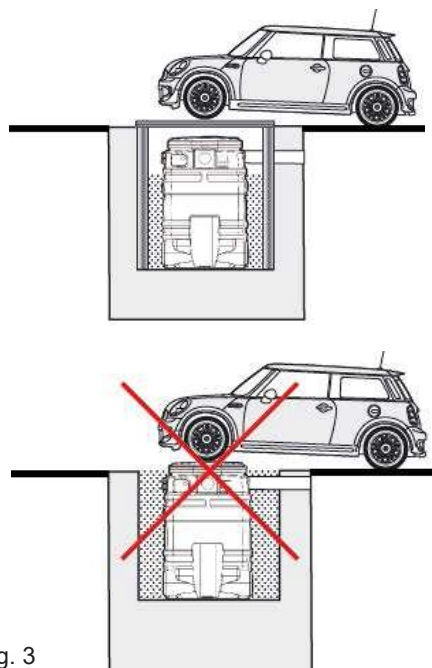
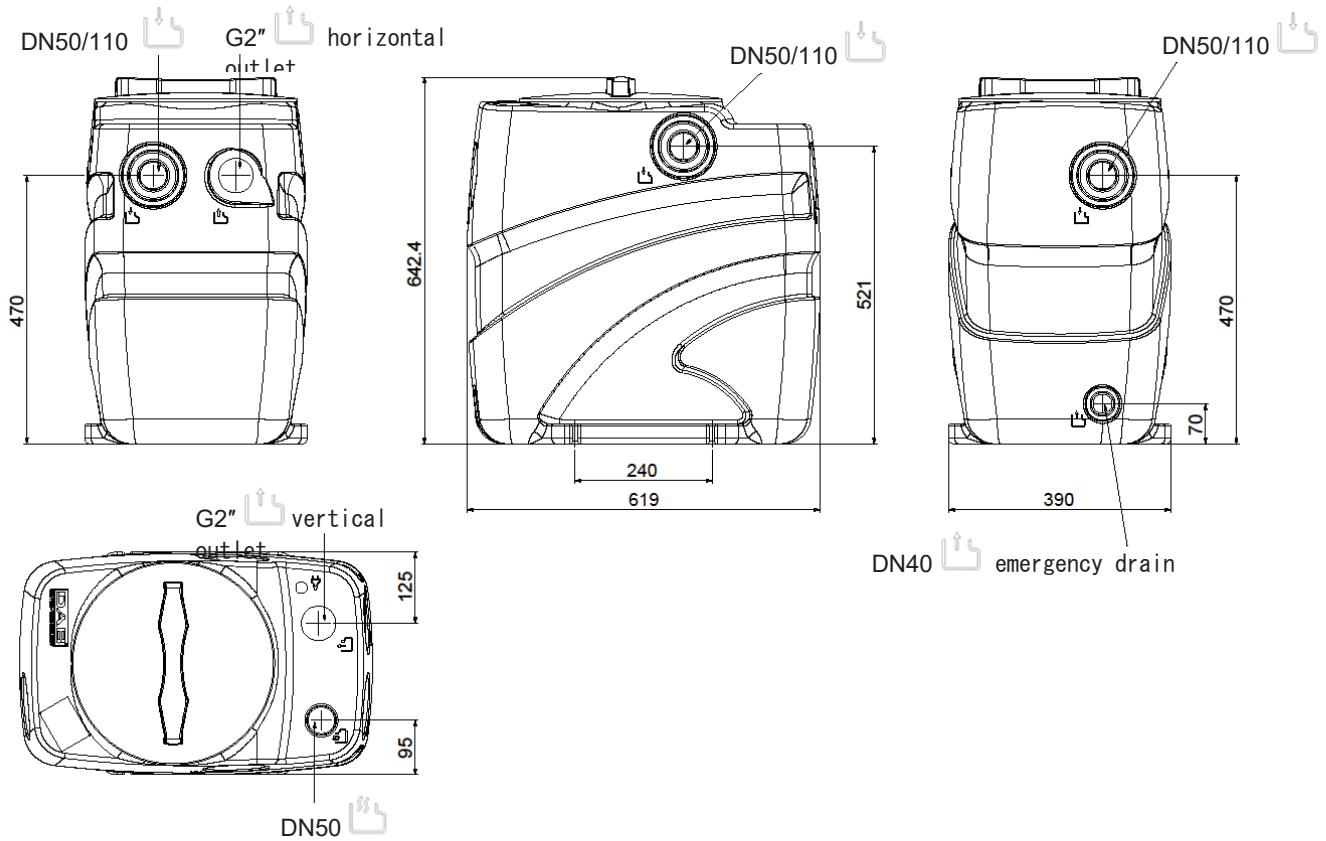

Fig. 3





4.1 Dimensions and weights

The adhesive label on the package indicates the total weight of the system.
The dimensions below are given in millimetres.

Fekabox 110



Key to Symbols

-  Connection of delivery pipe or emergency outlet
-  Collection pipe inlet
-  Outlet of power cables and float cables
-  Connection of ventilation pipe
-  Recyclable material

5. TANK INSTALLATION

The lifting stations of the Fekabox 110 series have various inlet and outlet possibilities for the pipes. Depending on the type of installation and on the local standards in force it may be necessary to provide a siphon, a non-return valve on the pipe connecting to the public/private sewer network or to other ducts. Always refer to the local and/or national regulations, laws and standards in force. Anyway it is recommended to install check valves and interception valves upstream and downstream from the station. An example of installation is shown in chapter 4.



All the ducts must be installed in such a way that they are not stressed. The ducts must not exert stress on the station. Check that the electropump is securely fixed to the pipes and that all the hydraulic connections are tightened and watertight.

Where necessary provide suitable means for avoiding the transmission of vibrations and for protecting the pipes against the formation of ice.

5.1 Placing the tank inside the building

The tank may be laid on the floor, under the ground or housed in a masonry pit. Fig.2, Fig.3

In any case the surface on which it is laid must be perfectly horizontal and it must be ensured that the whole bottom of the tank is in contact with the surface.



For Fekabox 110 the cover of the tank is trafficable (**max. weight 100 Kg, see fig. 1**).

In indoor installations (garage, basement, technical room), the tank must be fixed to the ground using the slots provided to prevent rotations, as indicated in figure 4.

FIX THE TANK TO THE GROUND BEFORE USE
Use screws TE M8 with respective fixture, use specific washers for soft materials ISO 7093

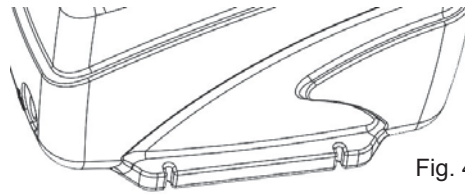

Fig. 4



Leave a free space of at least 60 cm around and above the station for installation and maintenance.

5.2 Placing the tank outside the building

If the tank would not be buried, to prevent damage to itself and to the seals, you should not expose it to heat sources such as direct sunlight can be at certain times of the year.



Do not position the lifting station directly on the ground. The site chosen must not have ground water and must not be subject to flooding. Suitably anchor the station so as to avoid rotation and floating. For this you can use the slots on the base of the tank.

There must be a horizontal base suitable to bear the weight of the station during its operation. Depending on the characteristics of the terrain it may be necessary to create walls with bricks, prefabricated components or concrete. Fill the space between the ditch and the station with sand and compact it suitably. Protect the station suitably against frost.



Do not drive vehicles over the cover (see fig. 3).

You can close the ditch with a cover (manhole) or other means for facilitating subsequent maintenance. Put up suitable signals indicating the presence of the station so as to avoid possible damage caused unintentionally. Ensure that there is sufficient space for installation and maintenance around and above the lifting station.



Position any capacitor holder and/or electric control panel in a place sheltered from the elements.

After having completed the hydraulic and electric connection, it is recommended to place clean sand around the container to reduce any movements caused by the system and/or by the surrounding terrain.

5.3 Making holes for the collection, delivery and ventilation pipes

Choose the inlet duct already prepared for the inlet pipe so that the arrival of the liquid does not disturb the operation of the pump float.

The Fekabox 110 tanks have multiple inlets, all marked with the symbol:

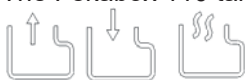

Make a hole in the tank in the determined areas, indicated by the symbols shown above.

To make the hole use a hollow cutter as shown in figure 5 (indicative figure).



Fig. 5

Tank model	Inlet diameter	Ventilation diameter	Cutter diameter	Emergency diameter
Fekabox 110	DN50	DN50	DN 44	DN 40
	DN110	-	DN100	

5.4 Gluing the collection and ventilation pipes

Before gluing the PVC pipe must be deburred and cleaned with a suitable solvent on the whole surface that will be in contact with the tank.

To ensure that it sticks firmly, the glue must be applied on the whole newly deburred surface, at least for a complete round.



Attention: Use glue suitable for sticking PVC materials with PE. Also check the drying times indicated in the specific instructions for the glue used.

For the discharge pipe 2"PP (Fekabox 110) use the multifibre nylon sealant Loctite 55, the polymerising GEI sealant Loctite 5331 or Teflon. For the steel pipe znb 2" and the other inlet connections use the most suitable glue in accordance with the standards of the local market.

5.5 Connecting the delivery pipe to the sewer network

Fekabox 110 tanks have a 2" GAS outlet connection. It must be fitted as shown in figure 6 after having drilled the required outlet (see par. 4.1 / 5.3).

To guarantee a perfect seal it is recommended to use Teflon or suitable glues depending on whether the material being glued is plastic (PP or PVC) or metal.

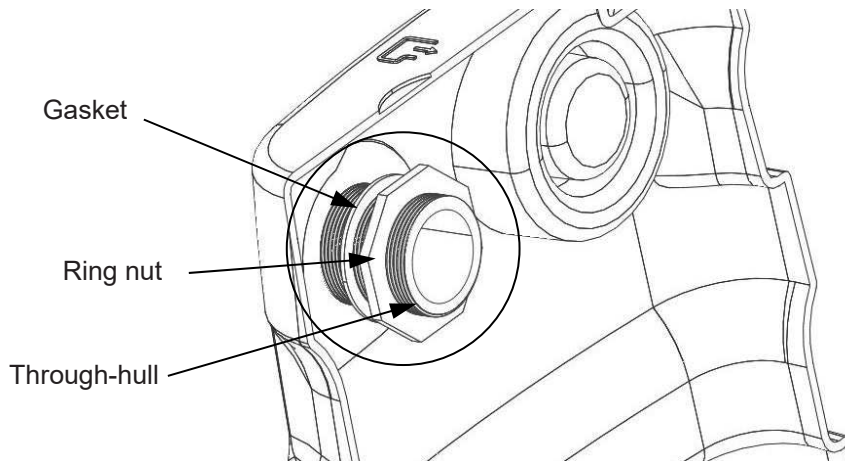



Fig. 6

5.6 Connecting the ventilation pipe

Remember to provide a ventilation pipe to avoid the formation of inflammable, explosive or toxic mixtures.

On the station identify the seat for the ventilation duct, marked with the symbol . Open the duct as indicated in point 5.3 and connect the ventilation pipe so that it can evacuate any condensate from the station. Check that the coupling is watertight.

The various national regulations may require different ratios between the diameter of the outlet pipe and that of the ventilation pipe. Ensure that the pipe outlet is in the open (for example, above the ridge of the roof if the station is installed inside a building) and that the exhaust gases cannot get into other places such as buildings, rooms and similar. Avoid horizontal stretches in the ventilation duct.

5.7 Closing the cover

The tank is shipped without the gasket fitted under the cover. Prepare it as in figure 7B after having removed the film, fig. 7A

Check that the gasket of the cover is lying in the bottom of its seat and is not twisted before screwing the cover onto the tank.

Check that the gasket does not slip in the thread during screwing. In case of installation inside buildings, the cover must be screwed right down to guarantee that the station is hermetically sealed against liquids and gas.

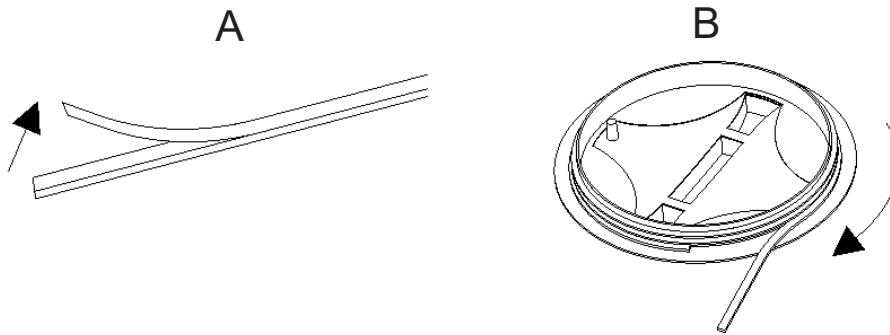



Fig. 7

5.8 Provision for emergency drainage

On the rear, at the base of the station, is a connection for an emergency drainage system, marked by the

symbol . You can use the connection to attach a secondary pump (for example a manual diaphragm pump), the discharge pipe of which must be independent from that of the internal electropump in the station. Identify the seat for the duct on the bottom of the station, open the duct and connect the emergency drainage pipe. Check that the coupling is watertight.

5.9 Non-return valve

Install a non-return valve in the pipe connecting to the public/private sewer network. This will avoid the reflux of liquid. Place the valve at a distance of at least 1 metre from the lifting station to allow the flow of liquid, moved by the pump, to open the shutter of the valve (unless indicated otherwise by the manufacturer). Always refer to the local and/or national regulations, laws and standards in force.

The non-return valves are available as accessory kits.

5.10 Interception gate valve

Install an interception valve in both the inlet pipe and the delivery pipe (connection to the public/private sewer network). In this way maintenance work can be carried out without having to drain the whole system. Gate valves or ball valves may be used.

The interception valves are available as accessory kits.



See example of installation in chapter 4.

6. PUMP INSTALLATION

Not applicable for models Fekabox 110 which have the pump already fitted inside.



Ensure that the difference in level between the pump and the sewage network is compatible with the pump performance.

Fekabox 110 I:

The Fekabox 110 is delivered with an installation kit containing respectively the parts in figure 8 for installation of both the vertical and the horizontal outlet.

For the assembly of the kit, see figure 8

1. Adapter 2"F – 1"1/4M (not necessary for Feka VS-VX)
2. Curved hosetail, thread 2"x50 PP
3. Pipe tightening clamp in AISI304 DIN 3017
4. Short length of pipe in rubberized fabric 57x50 l=350
5. Curved hosetail 2"PP
6. Coupling for tank 2"PP

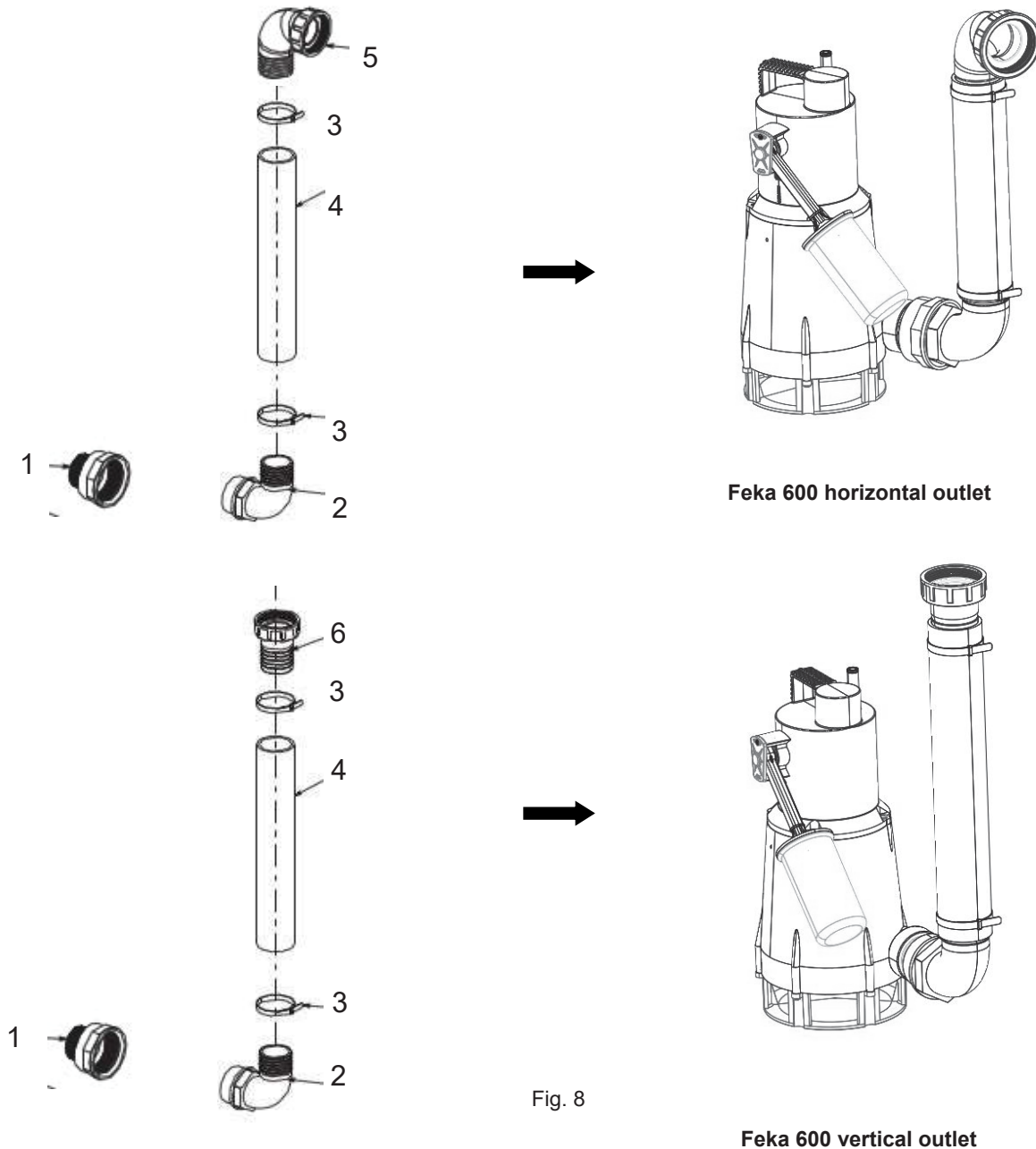

Fig. 8

FEKABOX 110 I

FEKA VS

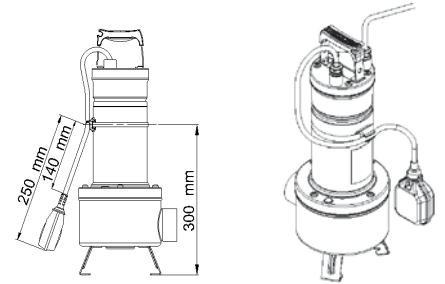
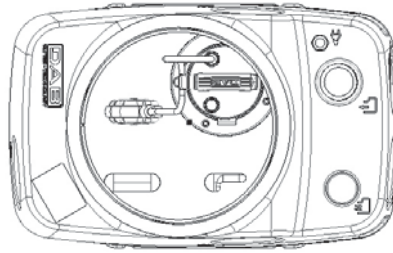
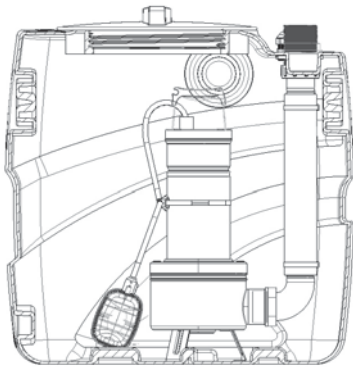

Fig. 9A

FEKA 600

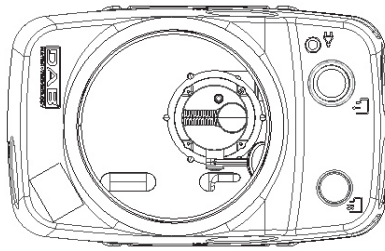
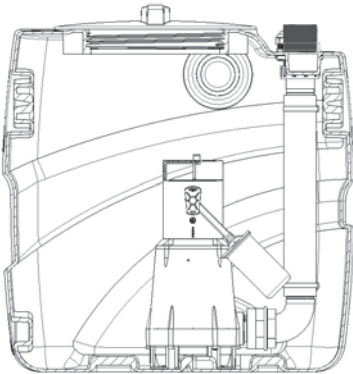

Fig. 9

PREPARED FOR THE FOLLOWING PUMPS

FEKABOX 110	FEKA 600 MA
	FEKA VS-VX 550 MA
	FEKA VS-VX 750 MA

7. ELECTRICAL CONNECTIONS

Before connecting the system to the mains, ensure that the mains voltage is the same as the value indicated on the pump data plate.

It is recommended to apply the pump data plate (supplied in the package in addition to the one already applied on the pump by the manufacturer) on the tank, in a clearly visible position, or on the control box.

The connection must be made as follows:

Pump:

Pass the pump cable through the cable gland supplied in the kit.

Assemble the cable gland on the tank, next to the symbol  , as shown in figure 10. Then tighten the ring nut of the cable gland on the inside of the tank.

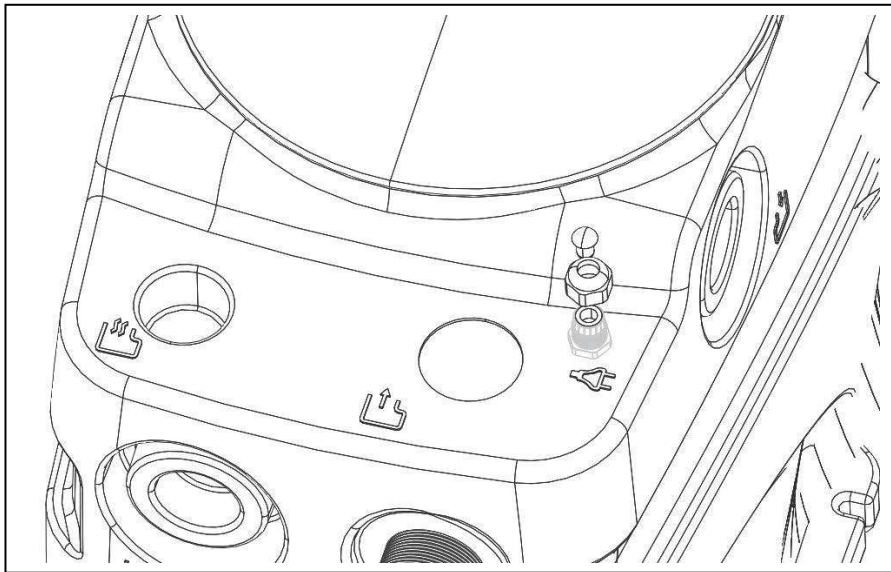

Fig. 10

8. FIRST START-UP



Before starting up the electropump check that in the tank system there is no residue or other material that could harm the correct operation of the system.

In this phase you can leave the interception valve in the inlet pipe closed and fill the lifting station with clean water. Open the interception valve in the delivery pipe and check that the pipes are tightened and perfectly sealed and that the electropump is working correctly. Check also that the electropump is primed. Open the interception valve in the inlet pipe and check that the station is working correctly.



The flow of liquid coming from the various utilities must not prevent the correct operation of the floats present in the container.

In the case of a three-phase electropump, check that the impeller is turning in the correct direction. Check also the electropump manual. Check that the levels of float intervention are correct, and if necessary adjust them to suit the actual needs of the system. When there are two electropumps, the floats must be adjusted so that the second pump starts after the first and only if the first is not able to send to the sewer duct as much liquid as arrives from the various utilities. Check that the electropump cannot become unprimed during operation. Check that the number of starts per hour is compatible with the characteristics of the system components. Check that the system is working correctly and put it into service. Close the cover or covers of the station, screwing them into place. If necessary, fix the cover in its seat in such a way as to prevent unauthorised opening of the cover (see chapter 5.7).

8.1 Operating flow rate

It must be guaranteed that the speed of the liquid in the delivery pipe is at least 0.7 m/s and lower than 2.3 m/s.

8.2 Operation

When the liquid in the tank reaches the level corresponding to the closure of the float contact that commands the electropump, the pump starts and gradually empties the container. The electropump stops when the liquid reaches the minimum level corresponding to the opening of the float contact. When there are two electropumps, the floats must be adjusted so that the second pump starts after the first and only if the first is not able to send to the sewer duct as much liquid as arrives from the various utilities. There may be a float placed higher than the others in the pumping station, its function is to indicate the presence of an abnormally high level of the liquid in the tank.

9. MAINTENANCE

After starting up the plant, it is advisable to inspect and clean it, especially the no return valve, about every three months. This interval may be increased after the first inspections have given a favourable outcome. Clean the pump accurately, removing any foreign bodies stuck in the intake grille and check that the float moves freely. If necessary, remove the pump from the tank. It is recommended to clean the system at least once a year with running water, operating the pump repeatedly.

10. TROUBLESHOOTING

FAULTS	CHECK (POSSIBLE CAUSES)	REMEDY
1. Water is overflowing from the tank and the pump is not working. (In this situation the alarm, if installed, must intervene. Otherwise check the alarm system installation instructions.)	A. Delivery pipe blocked. B. The pump is not correctly connected to the delivery pipe. C. No return valve blocked. D. Interception valve closed. E. Pump characteristics are insufficient. F. The pump intake grille is blocked. G. The impeller is worn or blocked by foreign bodies.	A. Remove the obstructions. B. Check that the pump slide is at its full limit (only for 280 l tanks). C. Clean the valve. D. Open the valve. F. Remove the obstructions. G. Remove the obstructions.
2. The alarm, if installed, intervenes, but the system operates regularly.	A. Check the exact position of the alarm float.	A. Repeat the checking and installation operations.

11. DISPOSAL

This product or any part of it must be disposed of correctly:

1. Use public or private local systems for waste collection.
2. If that is not possible, contact Dab Pumps or the nearest authorised service workshop.