

ULTRA COMPACT

DEPTH 250 mm
HEIGHT 525 mm

DESIGN

It gives a new style to the boiler room. Supporting frame designed for reducing the space.

COMPACT

IT NEEDS HALF SPACE USUALLY REQUIRED TO THE TRADITIONAL SYSTEM

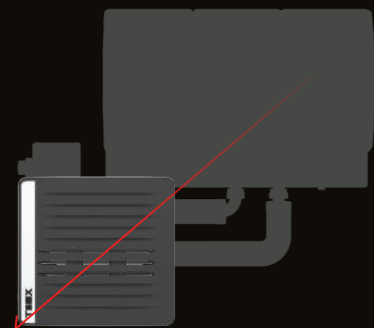

-50%

For perfect installations also into the smallest boiler room.

ADAPTABLE

It can be installed in 3 different positions

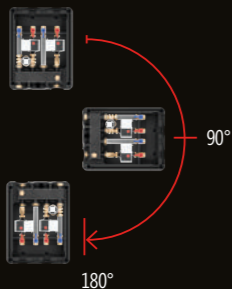

180°

100%

LOVATO **LOVATO**
Smart Energy Solutions Smart Energy Solutions

DO MORE, with less.

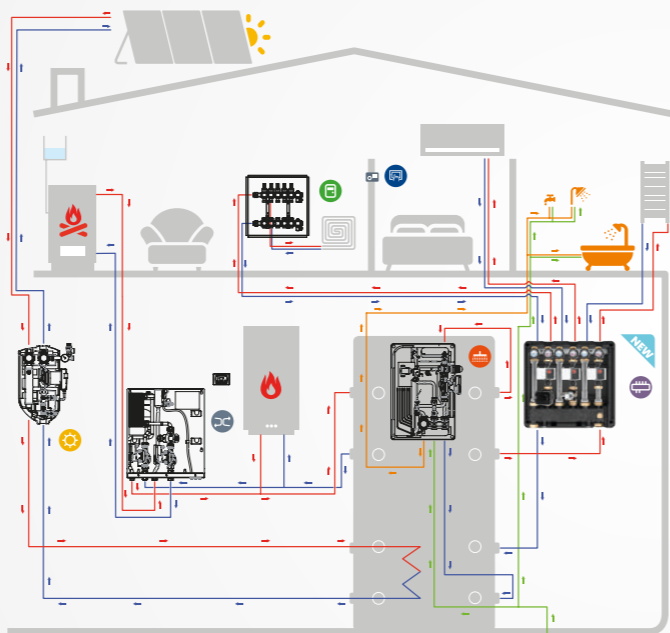

DO MORE, with less.

T-BOX DISTRIBUTION SYSTEM

The new distribution system for the heating zone system, design, compactness and power.

DESIGN, COMPACT AND POWERFUL.



2X

Double power in half space

DN20

3/4"

DN25

1"

LOVATO S.p.A.
Via Selva, 4/a
37040 Gazzolo d'Arcole
VERONA - ITALY



info@lovatospa.com
+39 045 618 2012
fax +39 045 618 2017
#lovatospa

www.lovatospa.com

www.lovatospa.com

TBOX
DISTRIBUTION SYSTEM

DO MORE, with T-BOX

DESIGN

Every **T-BOX** part is carefully studied for granting high performance, efficiency and easy installation to the installer

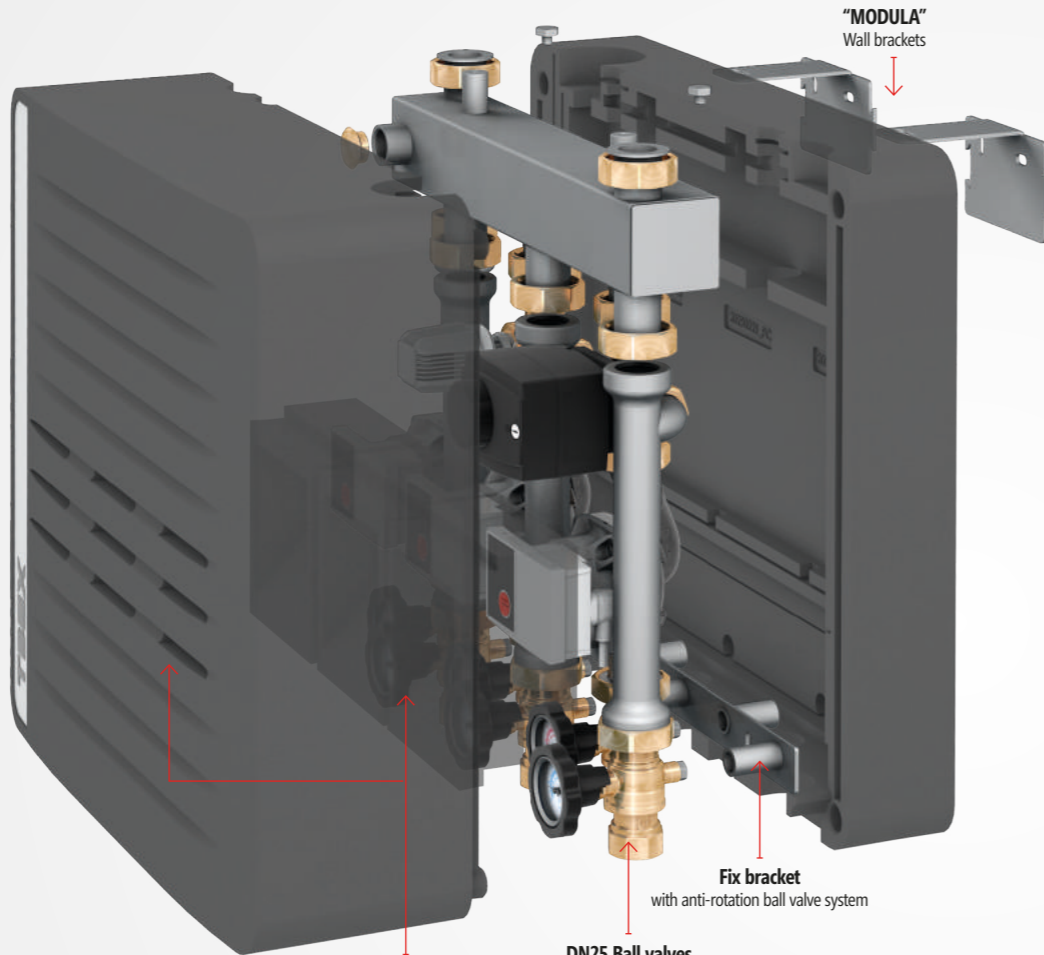
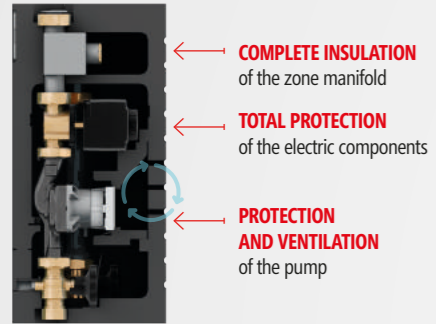

POWER

T-BOX is available in two versions, DN20 and DN25 with really high performance for satisfying several request.

THE "SECRET" IS THE NEW GENERATION OF **DN20 and DN25 "DUO SYSTEM" ZONE MANIFOD/HYDRAULIC SEPARATOR**

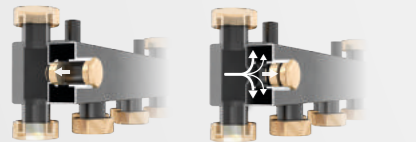

Screeing the threaded cap to the end of the position, the supply/return sections are completely separated.

DN 25 - 1" DUO SYSTEM
MAX FLOW RATE 3000 l/h
MAX HEATING POWER (Δt = 20° C)

70 KW

DN 20 - 3/4" DUO SYSTEM
MAX FLOW RATE 2000 l/h
MAX HEATING POWER (Δt = 20° C)

46 KW

LIGHTWEIGHT INSTALLATION

T-BOX is easy to install, small, lightweight, easy to handle. **It can be install by a single operator!**



MODULAR

Several configurations for different requirements. **T-Box** is desgind to be modular (2-3-4 zones).

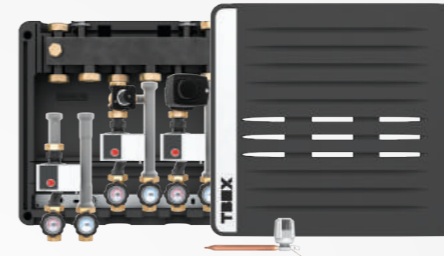

DN20 2-3-4 ZONES

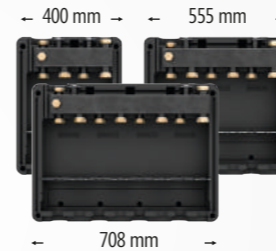

DN25 2-3 ZONES



Fix bracket+insulation box for the installation of the distribution units into the black EPP 60 g/l box and zone manifold/hydraulic separator.

DN20 GROUPS

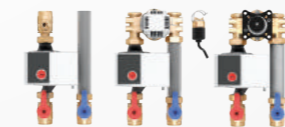

T-BOX *D* T-BOX *PF* T-BOX *TS*

DN25 GROUPS



T-BOX *D* T-BOX *PF* T-BOX *TS*

3 DISTRIBUTION UNITS ARE AVAILABLE:

T-BOX *D* direct unit, **T-BOX *PF*** fix-point mixing unit (constant temperature) and **T-BOX *TS*** modulating temperature mixing unit with heating controller.

All distribution units are equipped with high efficiency pumps. Electric actuators **ECOMIX** and thermostatic actuators are available.



APPLICATIONS

EXAMPLES

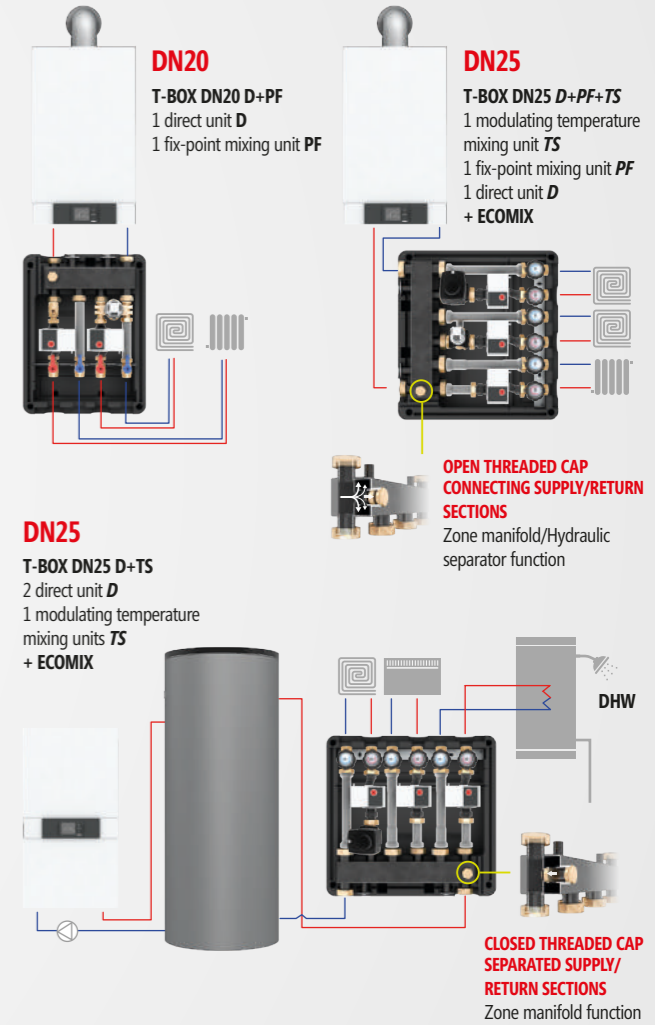

TBOX
DISTRIBUTION SYSTEM